

ANTIQUARIAN HOROLOGICAL SOCIETY

Electrical Horology Group

EHG Paper Number 68

English Clock Systems Limited 1-Second Master Clock

Martin Ridout

This paper sets out the findings from the first two years of a continuing survey into the history and design of the English Clock Systems Ltd (ECS) 1-second pendulum master clock, and is based on an interim report presented by the author as a lecture to the Electrical Horology Group of the Antiquarian Horological Society in September 2001. (See AH Vol 26, No 4, December 2001, pp 437-438)

THE SURVEY

The survey to identify and record clocks was conducted both among members of the AHS and via an Internet website. This was combined with research into the company history using advertisements and reports published in the horological press, and records kept at Companies House, along with interviews with two retired ECS employees. The clock's design was studied, and the relationship between design changes and serial numbers recorded. Production patterns and quantities were also determined.

The survey has recorded a total of 63 clocks to date.

BACKGROUND

The initial design for the ECS master clock probably came from Reginald Bailey and Thomas Johnstone who started a company called **Synchro Time Systems Limited** (STS) which was registered on 4 August 1936 with a nominal share capital of £1000. The original Directors of the company were:

Reginald Alfred Bailey (Electrical Engineer)

Thomas Johnstone (Electrical Engineer)

F.D.S. Jerrard (Gentleman)

W.E. Thorne (Gentleman)

J.T. Bett (Solicitor)

G.E. Bouskell-Wade (Solicitor)

All six were also shareholders.¹

Reginald Bailey had been involved with industrial timekeeping since 1916 when he was fourteen years old, being particularly interested in the technical aspect of horology.² The main business of STS was the installation and maintenance of Ericsson time recording equipment imported from Sweden, and the

installation and maintenance of synchronous turret and advertising clocks.³ The development of the 1-second master clock was carried out largely by the works manager, a Mr Powell.⁴

At an Extraordinary General Meeting of the shareholders on 5 November 1937, just over one year after the company was formed, the £1000 initial capital was increased to £2000 and the value and allocation of shares was changed to reflect the cash input from S. Smith & Son (1934) Ltd. This move gave S. Smith & Son (1934) Ltd. 3000 of the 4000 available shares in STS and a seat on the Board.⁵

STS thus became the Industrial Branch of Smiths, dealing with "Sectric" time recorders, turret and exterior clocks, advertising clocks and master clock systems.⁶ Initially it retained its own company name and the trade mark name of "Relyon", and traded from its address at Relyon House, 57/63 Wharfedale Road, Kings Cross, London. It had contracts with many well known names such as K.L.G. Spark Plugs, Gillette Industries, Littlewoods Ltd., Prudential Assurance Company and the Financial Times offices in London.⁷ Neon-lit turret clocks and advertising clocks using a Smiths "Sectric" synchronous motor and reduction gear formed a large part of the company's work in 1938.⁸

On 28 March 1939, a Special Resolution was passed by the Board of STS to change the name of the company to **English Clock Systems Limited**⁹, and in May 1939, two of the original shareholders, Messrs. Bett and Bouskell-Wade, transferred their shareholdings to S. Smith & Son (1934) Ltd., thus giving Smiths 3506 out of 4000 shares.

In June 1939, an English Clock Systems Ltd. advertisement in the Horological Journal mentions "pendulum master clocks", so the design was probably complete and in a marketable form by then. This is the earliest published record found so far of the master clock.

In December 1944, the shareholding of S. Smith & Son (1934) Limited was transferred to Smiths English Clocks Ltd.¹⁰ and by December 1947 share ownership had changed again, to leave Messrs. Bailey and Johnstone with 20 shares each, and Smiths English Clocks Ltd with the remaining 3960 shares.¹¹

In February 1949, Reginald Bailey died at the age of 47, and in 1950 his shareholding was also transferred to Smiths English Clocks Ltd, giving them 3980 of the 4000 shares. The remaining 20 shares were still held by Thomas Johnstone, one of the founders of the original company.¹²

In February 1955, Thomas Johnstone transferred his twenty shares¹³, giving nineteen to Smiths English Clocks Ltd. and a single share to Mr. D.W. Barrett¹⁴, who had previously been a shareholder from 1944¹⁵ to 1947¹⁶. Smiths English Clocks Ltd. now had 3999 of the 4000 shares. In 1960, Smiths acquired the last remaining share.

ECS had depots in Birmingham, Manchester, Leeds, Glasgow and Belfast, each with a depot manager who was responsible for sales and two or three service staff. There were also foreign agents in Greece, Holland, South Africa, Sweden and Algeria, although none were very active.¹⁷

In September 1969, ECS moved its operating base to Park Royal in West London, and in October 1980, it had been taken over by Blick.

OVERVIEW OF THE CLOCK

The clocks have a 1-second Invar pendulum with a 17 pound cylindrical bob, and are impulsed every 30 seconds by an electrically reset gravity arm. There are two case styles; flat-top (Fig. 1) and round-top (Fig. 2). The movement is built on a cast iron A-frame (Fig. 3). There is a 15-tooth count wheel, two resetting coils mounted vertically above the gravity arm, a capacitor (with a spark quench resistor behind the casting) and a current setting rheostat.

Fig. 1



Fig. 2



Flat-top case style

Round-top case style

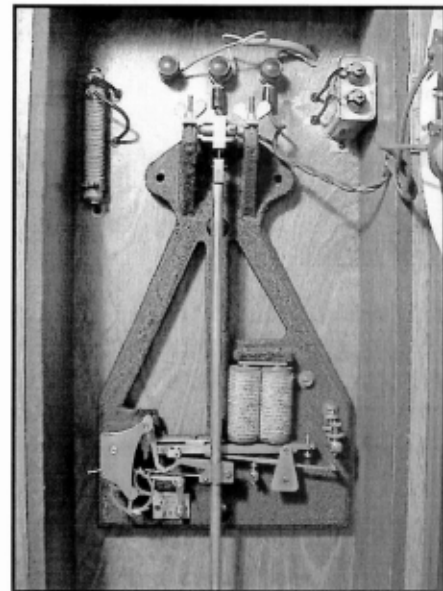

Fig. 3

Cast iron A-frame movement

CLOCK SERIAL NUMBERS & DATING

All clocks are serial numbered on the A.R.N. plate mounted on the movement casting. There are 5 groups of serial numbers:

sub-1000 series	(Sample and dating too vague to give dates)
1000 series	up to approximately mid 1950
10,000 series	up to late 1954
20,000 series	up to mid 1957
30,000 series	last recorded clock mid 1966

As the earliest recorded mention of the master clock is in an advertisement in June 1939, production may well have started just before World War II broke out, but would almost certainly have been reduced or suspended during the war. Dating of the early clocks (sub-1000 and 1000 series) is almost impossible as they were not dated during manufacture. There is a published report regarding a clock with serial number 196 giving a purchase date of 1945/6 and a possible manufacture date of 1938, but the latter is not a verifiable date¹⁸. Two examples in the 1000 series have installation dates recorded in pencil on the inside surface of the pilot dial (1948 and 1950), and one clock's serial number is shown on a dated technical drawing (1949). Until evidence to the contrary is found, 1945 has been taken as the probable start of the main production and marketing.

The serial numbers are not a true reflection of the actual number of clocks made as numbering recommenced each time a new series was started. Some obvious design changes happened at serial number boundaries, and some design changes were made during a series. The reasons for the numbering changes are not always obvious.

From the latter part of the 10,000 series onwards the movement of the pilot dial was given a date code that was stamped into the rectangular brass plate on which the movement is constructed. This becomes the prime source of dating information. Initially this code was in the form of two digits for the year, followed by one or two digits for the month, e.g. 547 gives July 1954 and 5512 gives December 1955. Around 1961 or 1962 this code changed to become one or two digits for the month and one digit for the year within the 1960 decade. e.g. 113 is November 1963 and 54 is May 1964.

Even this dating evidence is not too accurate as the slave movements were also produced for individual slave dials and for other clocks apart from the master clocks, and it is suspected that slave movements were dated at the time that a batch was manufactured, but were not taken from stock in strict rotation when assembling the master clocks. Thus, a clock with a

higher serial number may have an earlier dated pilot movement than an adjacent lower serial number clock. This gives an uneven distribution to the production pattern. (See Chart 1).

DESIGN CHANGES

1). There were two major design changes for which dates can be established.

a). **Case and dial style.**

The first change coincides with the start of the 20,000 series in late 1954 and is purely cosmetic. The case style is changed from flat-top to round-top; the dial is given Arabic numerals instead of Roman, with a painted background instead of silvered; and the hands are changed to a more 'modern', sleeker shape (Figs. 4 & 5). An intermediate form of hand is also used from this time onwards where a tail from the original design is retained, presumably as a counterbalance, along with the main part of the new design (Fig. 6).

Fig. 4

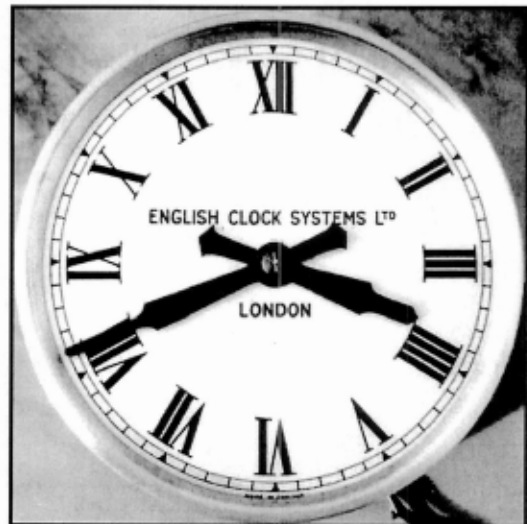

Old style dial

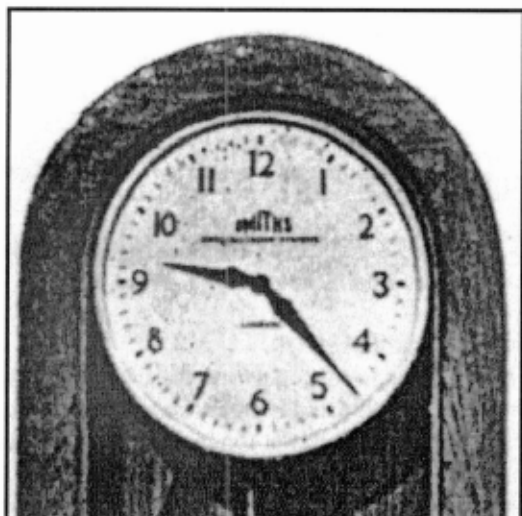

Fig. 5
New style dial & hands

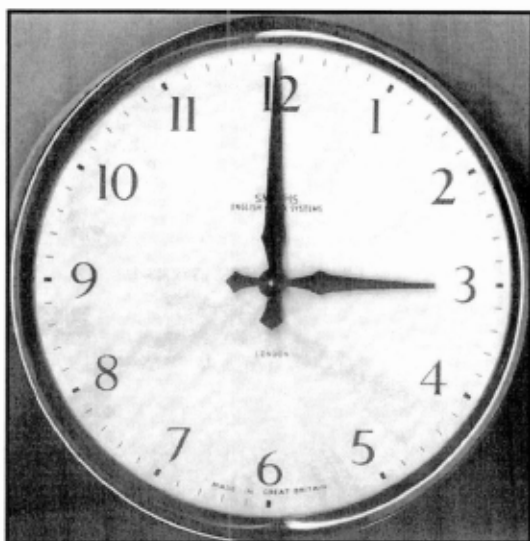

Fig. 6
Intermediate style dial & hands

b). Contacts.

The other major change was technical, occurring part-way through the 30,000 series towards the end of 1959, where the contacting arrangements were changed from double-contact to single-contact. In the double-contact design (Fig. 7), the moving contact on the armature bridges two fixed contacts to complete the circuit. This obviated the need for a flexible wire connection from the armature to the frame of the clock. A flexible wire could fracture, or could stiffen over time and impede the action. The original double-contact arrangement had always been a source of unreliability^{19 20} as the two sets of contacts

are both required to make a reliable connection to complete the resetting circuit, and therefore the contact pressure is shared between them. In the later single-contact design (Fig. 8), the armature became part of the circuit and a flexible connection was then required back to the baseplate. Contact pressure was thus doubled, giving a more reliable contact.

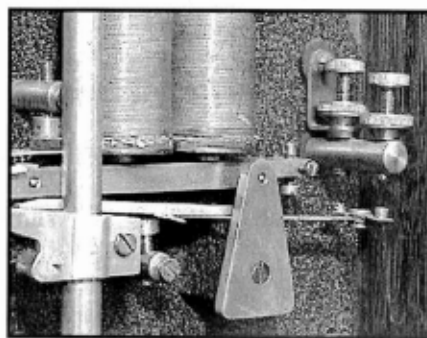

Fig. 7
Double-contact & Brass 'L' link

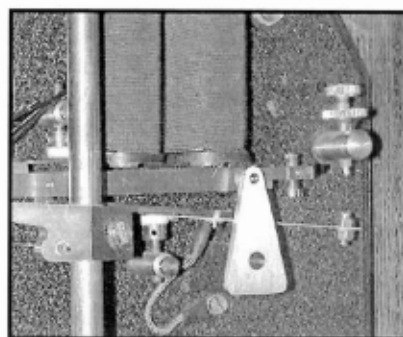

Fig. 8
Single-contact

2). There were also a number of more minor changes, none of which have yet been definitely dated or related to changes in serial number series. These are:

a). Impulse pallet form.

Up to around the end of the 10,000 series, the impulse pallet was parallel sided with a curved form around the pendulum rod (Fig. 9). Later pallets were of a diamond plan form with the widest part of the pallet around the rod (Fig. 10). There does seem to be a slight difference in the profile of the impulse slope between examples, with some being steeper than others (Fig 11), but this has not been researched in detail as it would involve at least a closely matching photograph, if not personal examination, of every recorded clock.

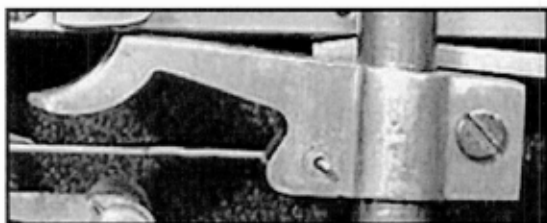

Fig. 9
Impulse pallet up to the end of the 10,000 series

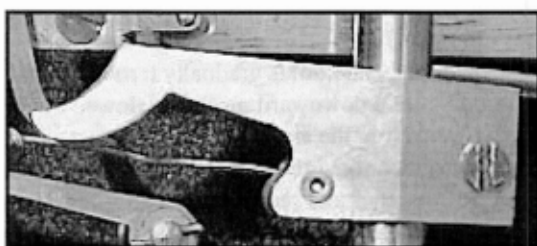

Fig. 10
Impulse pallet 20,000 & 30,000 series

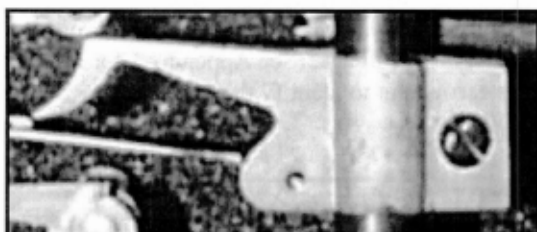

Fig 11
Impulse pallet 10092 - example of a steeper slope

b). Connection to double-contact pillar.

Where clocks have the double-contact arrangement, both contacts are mounted on a single pillar and are insulated from each other and from the baseplate. The rear contact is connected through the baseplate via an insulated bush and a brass 'L' shaped link (See Fig. 7). Towards the end of the 10,000 series, the brass 'L' link gives way to a wire link.

c). Pilot dial movements.

Early pilot dial movements have a solid composition index wheel (Fig. 12). This style has only been recorded in two clocks, 1006/S & 1021/S, both dating to pre-1950.²¹ These early movements also have "SEC" printed on the bridge plate as the movement maker, and the type number is stamped into the square brass plate. Later movements from around the start of the 1950s have a crossed out brass wheel and are printed with ECS and the type number

on the bridge plate (Fig.13). All slave movements were made and supplied by Smiths English Clocks Ltd.²²

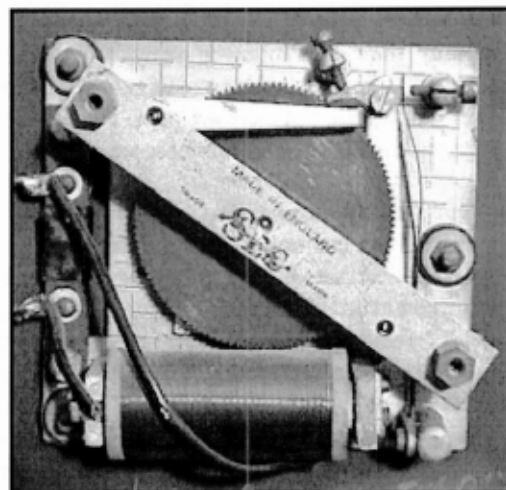

Fig. 12
*Early slave - solid composition wheel
(Type 205/19)*

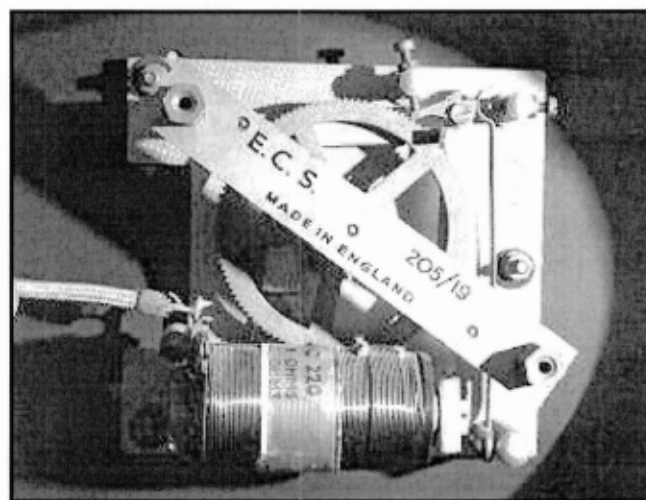

Fig. 13
*Later slave - Brass crossed out wheel
(also Type 205/19)*

Most clocks in the survey sample contain a pilot dial with a movement of type number 205/19. There is a period from January 1954 to September 1958 when dials were supplied with a type number 205/12 movement. ECS specifications for type 205/12 have been found, but not for the more common 205/19. From survey responses, both types appear similar and were suitable for a dial up to 12 inches diameter. Specifications of slave movements are given in Appendix 2.

A summary of all the major design changes and dates is given in Chart 2.

ENGINEERING & DESIGN - AN APPRAISAL

Generally, the design followed many of the principles that had been established by existing designers in the master clock field, but there are some areas where the design appears to deviate from best practice.

1). **Pendulum impulse action.**

The installation instructions that accompanied the clock specified that with the gravity arm on its catch and the pendulum at rest the shoulder of the impulse pallet 'E' should be directly in line below the pivot of the impulse roller 'D' (see Fig. 14). This means that impulse can only begin once the pendulum has swung to the right *past* its zero position whereas accepted practice is to divide impulse equally about the zero position.

2). **Gathering jewel position.**

The installation instructions specify that with the pendulum at rest the jewel 'S' be midway between two teeth as shown in the drawing (Fig. 14). The jewel is not working directly over the top of the count wheel, and must slide up a significant length of the back of the tooth it is about to gather. This must introduce unnecessary friction and reduce the freedom of the pendulum.

3). **Contact arrangements.**

As has been explained earlier, the double-contact arrangement could be unreliable.

4). **Armature design & termination of impulse.**

The armature 'J' (See Fig. 14) is pivoted at its left-hand end in the gravity arm and is supported by the felt-buffered stop 'Q'. As the gravity arm (which is pivoted at 'K') falls, the armature rocks about stop 'Q' and the moving contact 'M' rises to meet the fixed contact(s). The right-hand half of the armature, which carries the moving contact, is made of spring steel and flexes under the weight of the gravity arm after the contacts have met. The gravity arm roller does not run off the end of the impulse curve, but impulse to the pendulum is gradually terminated as the gravity arm's downward motion is slowed by the springy element in the armature contact arm and by the growing electromagnetic resetting force. Impulse therefore continues at a reduced level *after* the contacts have made. However, the rate at which the electromagnetic resetting force builds is dependent on battery condition and these factors, it is believed, make the end of impulse variable, and the total impulse energy imparted to the pendulum dependent partly on battery condition. The effect is only very small, and only likely to be a problem under certain circumstances, e.g. where the clock is run from dry batteries that will age. (See Appendix 1 for notes of tests carried out to identify this effect).

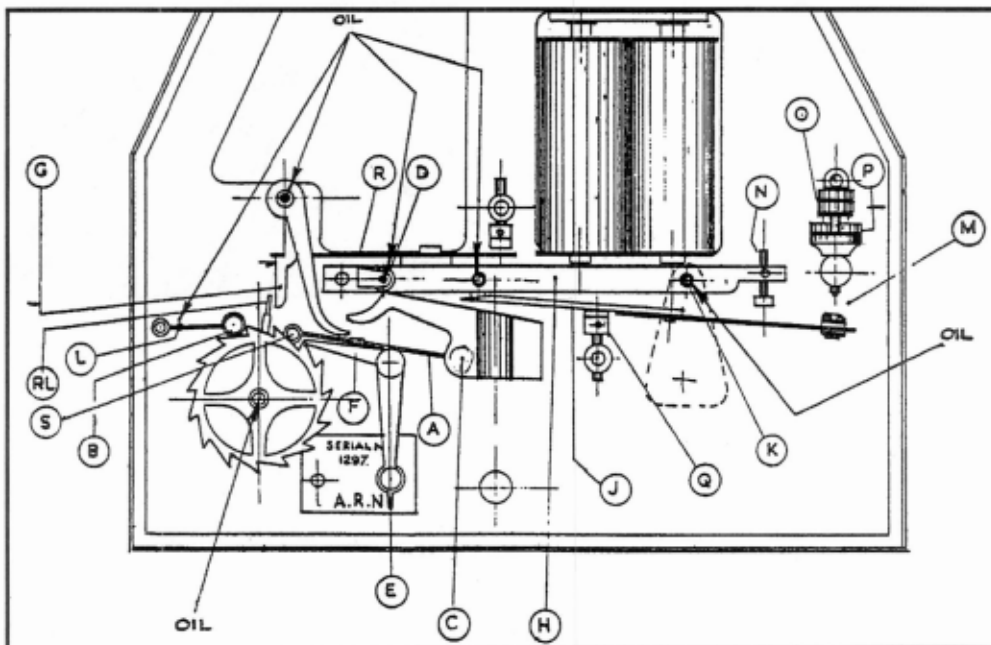

Fig. 14

General layout of master movement showing positions of roller 'D', pallet 'E' and jewel 'S' with pendulum at rest. (From an ECS drawing)

SPECIAL EXAMPLES

Two variations from the normal pattern of clock have emerged from the survey.

1). Mercury Switch.

There are three clocks recorded, all in South Africa, whose contacts have been replaced by a mercury filled glass tilt switch mounted on the right-hand end of the gravity arm.

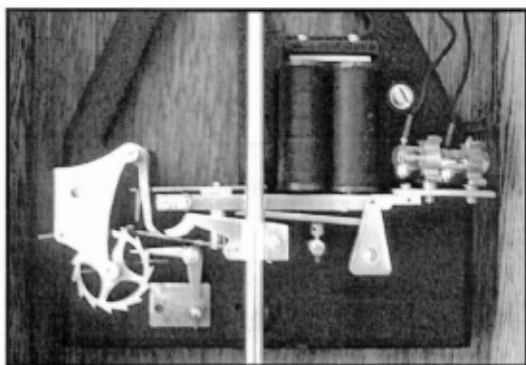

Fig. 15
Mercury switch modification

These modifications were carried out by the ECS agent in South Africa, United Clocks Sales (PTY) Ltd., from around 1960. Several master clocks in South Africa were modified²³, although only three have been recorded in the survey.

2). Master clock with seconds dial.

Two clocks have been recorded in the UK with a suffix to the serial number of 'S'. These are both early flat-top case clocks, with serial numbers 1006/S and 1021/S, probably dating to the second half of the 1940s. The suffix 'S' denotes a clock with a seconds pilot dial (Fig. 16).

Seconds pulses are derived by means of an additional short arm fixed to the pendulum rod projecting to the right and level with the bottom of the frame casting. This carries an almost circular horse-shoe magnet below which is a soft iron armature attached to a contact set which is mounted on the frame casting with a screw and two steady pins (Fig. 17). The magnet passes over the armature and causes the contacts to close at the centre of the pendulum's swing, so giving true seconds pulses of short duration. There is an auxiliary relay mounted on the backboard of the case below the frame casting.

Fig. 16

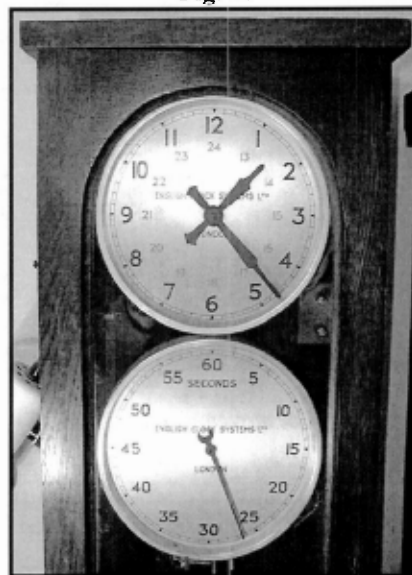

Clock 1006/S with seconds slave

Fig. 17

Seconds movement

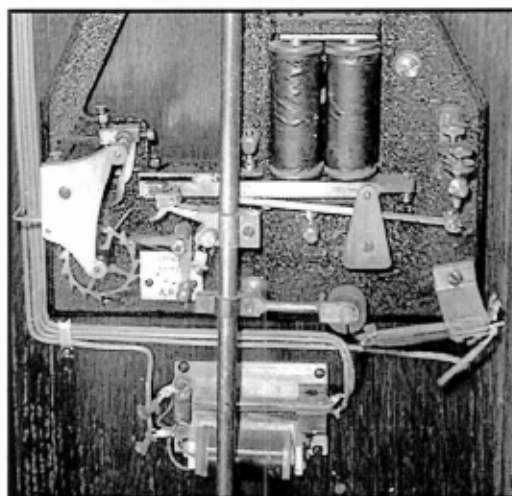

The arbor of the seconds pilot dial carries an insulating drum with a conducting sector (Figs. 18 & 19). As the drum rotates with the seconds arbor, a pair of fixed contacts wipe the drum and connect with the conducting sector for a 5 second period each minute. The numerals 55 and 60 on the seconds dial are painted red, with all other numerals in black, so the 5-second sector should logically relate to the last 5 seconds of the minute. However, the drum with the contact sector can be rotated on the seconds arbor and locked in any position.

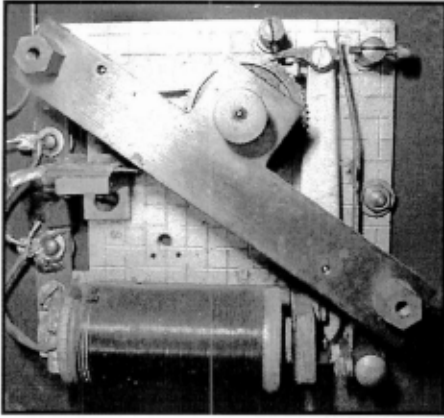

Fig. 18
Seconds pilot movement (type 205/18)

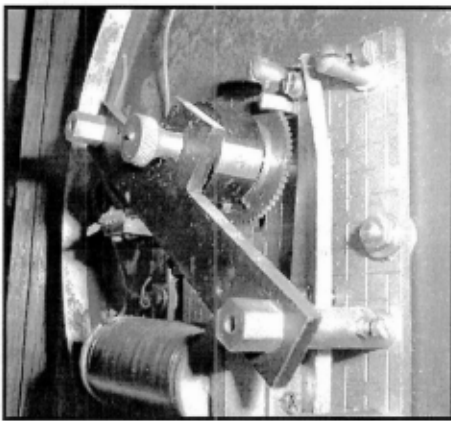
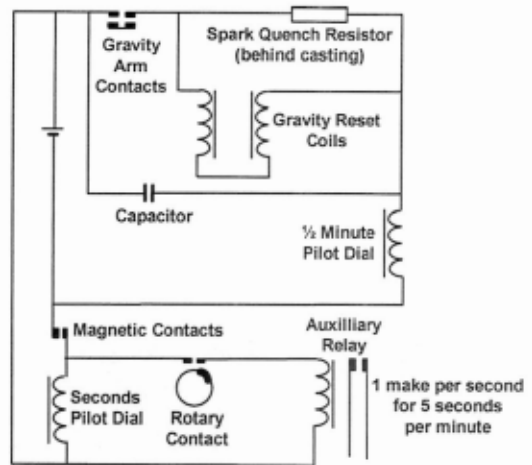

Fig. 19
*Seconds pilot movement, showing
insulating drum & conducting sector*

The wiring in this clock is not original or complete, so the function of the auxiliary relay and 5-second contacts is conjecture. A possible scenario is that the wiping contact allowed the auxiliary relay to operate once per second for 5 seconds per minute as shown in Fig. 20. This would give 6 closures per minute.

Only one of these two 'S' clocks is complete with the seconds contacts and dial, the other having been altered back to a standard form. Empty screw holes in the A-frame casting and in the case attest to its original form being similar to the complete example.

Fig. 20



Possible circuit for seconds dial and auxiliary relay

SERIAL NUMBER ANOMALIES

There are three clocks which do not fit the pattern of the rest of the survey sample:

Serial number 1238 is an early double contact movement, but is in a post-1955 style round-top case with its original Roman style pilot dial which carries a pencilled installation date of June 1950. Perhaps a style-conscious owner changed the case.

Serial number 30408 is a single contact movement with an Arabic pilot dial marked with a date code for November 1963, but mounted in an early flat-top case. The date code on the pilot dial and the movement's serial number are contemporary. This is an isolated example of a flat-top case containing a later movement, and could be due to a replacement movement and pilot dial in an existing case.

Serial number 30129 is a single contact movement in a round-top case with an Arabic pilot dial. The slave date code and the clock serial number are contemporary, and put the date of the clock at November 1958. This is the lowest serial number clock recorded with a single contact movement, and there are no more single contact clocks in the survey sample until serial number 30243 dated October 1959, yet there are six other examples of double contact clocks in the interim. After clock 30243 no more double contact clocks have been recorded. Clock 30129 is, therefore, an isolated example of the single contact movement apparently produced a year earlier than the change appears to have been generally made.

PRICES

One Bill of Sale for an ECS system has been found from 1954:-

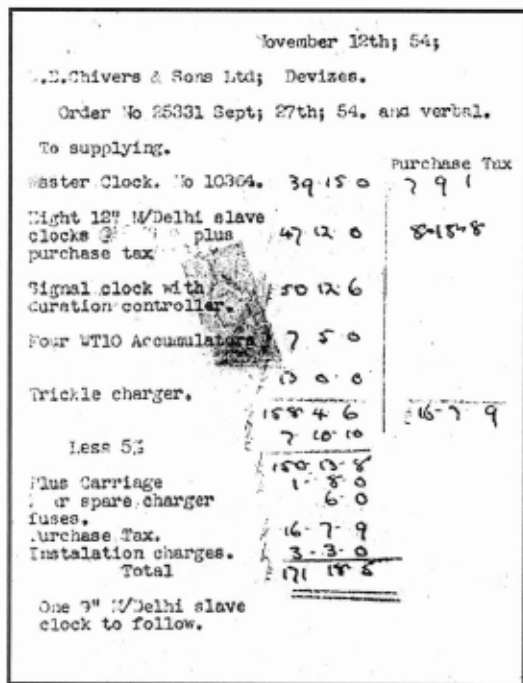

Fig. 21
Bill of Sale 1954

Based on inflation since 1954, the system would be priced around £3000 in 2002.

The following master clock price comparison is based on old price lists (excluding Purchase Tax) from the various companies:

ECS	£39-15-0
Synchrone	£36-10-0
Gents	£31-0-0

The ECS price is from the invoice above (1954). The Synchrone price is from a 1951 price list. (The Synchrone price in 1954 would have been very similar.)

The Gents price is calculated, based upon a comparison of 1970 price lists, where the Gent price is about 15% cheaper than the Synchrone in that year.

CONCLUSIONS

The 63 clocks recorded in the survey span the various serial number ranges fairly evenly and fit the

production pattern graph quite smoothly (Chart 1). It is not thought that there was a significantly larger number of clocks produced than has been suggested in that chart. As the serial numbers are not continuous over the various series, the total number of clocks shown on the left hand vertical axis of Chart 1 has been calculated by assuming that the number of clocks made in each series is given by the highest serial number recorded in that series.

The only serial number change to coincide with design changes is that from 10,000 to 20,000. Perhaps the other serial number changes were intended to confuse competitors regarding the numbers of clocks made.

The ECS master clock was one of the last of its type to reach the market and it needed to compete with the well established makes, primarily of Gents and Synchrone, both of whom had already been selling their master clocks for several decades. Gents produced an average of 360 clocks per year over the period from 1945 to 1960²⁴, and Synchrone produced around 160 to 200 clocks per year over the same period²⁵. English Clock Systems Ltd appear to have produced an average of 83 clocks per year of the double-contact version from 1945 to 1960, which dropped to an average of only 50 clocks per year from 1960 (after the introduction of the improved single-contact version) to 1966 which is the last recorded clock in the survey. In its early life, the ECS was also the most expensive of the three.

Although the quality of manufacture of the ECS master clock was mainly sound, there were design flaws. It did not introduce any major new technical innovation, and it proved to be less reliable than its competitors, due largely to the double-contact arrangement. Service record cards that have survived with three clocks in the survey show that, on average, three or four service calls were made each year with some years requiring six calls. There is one example of eleven calls in a calendar year.

The introduction of the improved single-contact version seems to have been too little too late to save the future of the clock.

ACKNOWLEDGEMENTS

My thanks go to all those who responded to the survey and to subsequent questions that arose. I am grateful to Arthur Mitchell for providing the initial data to get the survey started.

APPENDIX 1

Presented here is a brief description, with results, of tests carried out on clock 1021/S to try to establish if the clock's rate is dependent on supply current due to the springy element in the resetting armature allowing the gravity arm impulse to continue after the contacts have closed, and if found, to what extent this would affect the practical daily running of the clock.

If the clock was to be run from dry batteries, which was an acceptable power source according to the manufacturer, then as the batteries aged the voltage would fall and so would the current. Because of the effect of the springy part of the armature it is suggested that, as the supply current drops, the onset of the resetting action will be more sluggish and impulse will carry on slightly longer than with fresh batteries. Pendulum arc will therefore increase slightly and the clock will lose.

For the tests, the clock was set up as defined in the manufacturer's instructions, and as also defined in EHG Technical Paper 39. The clock was powered from a constant voltage power supply with a current

set to 320 milliamps. A switchable external resistance was arranged to allow the current through the clock system to be reduced to 295 milliamps without disturbing the clock.

Using a very accurate electronic timing device with an optical sensor the pendulum period was recorded and averaged over a five-minute window, and from this the daily rate was calculated and plotted against atmospheric pressure at that point in time. As the pendulum rod is made from Invar and the clock under test was in a stable temperature environment, period variations due to temperature would have been small and were ignored for this test. Recordings were taken at various times of the day over a number of days covering a range of atmospheric pressures. This was repeated a number of times with two different current settings of 295 milliamps and 320 milliamps, being the minimum and maximum currents at which the clock is designed to operate. Graphs were produced showing that, at a fixed current, atmospheric pressure changes and pendulum period changes follow fairly closely (Fig.A1); and that the daily rate varies as the current varies (Fig.A2).

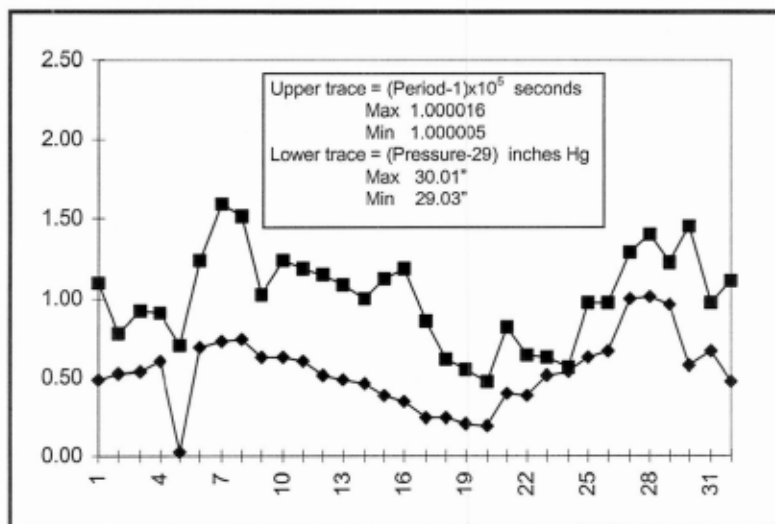

Fig. A1

At a fixed current, pendulum period (upper trace) follows atmospheric pressure (lower trace) fairly well. The two sets of data have been modified by constants to fit onto the same vertical axis.

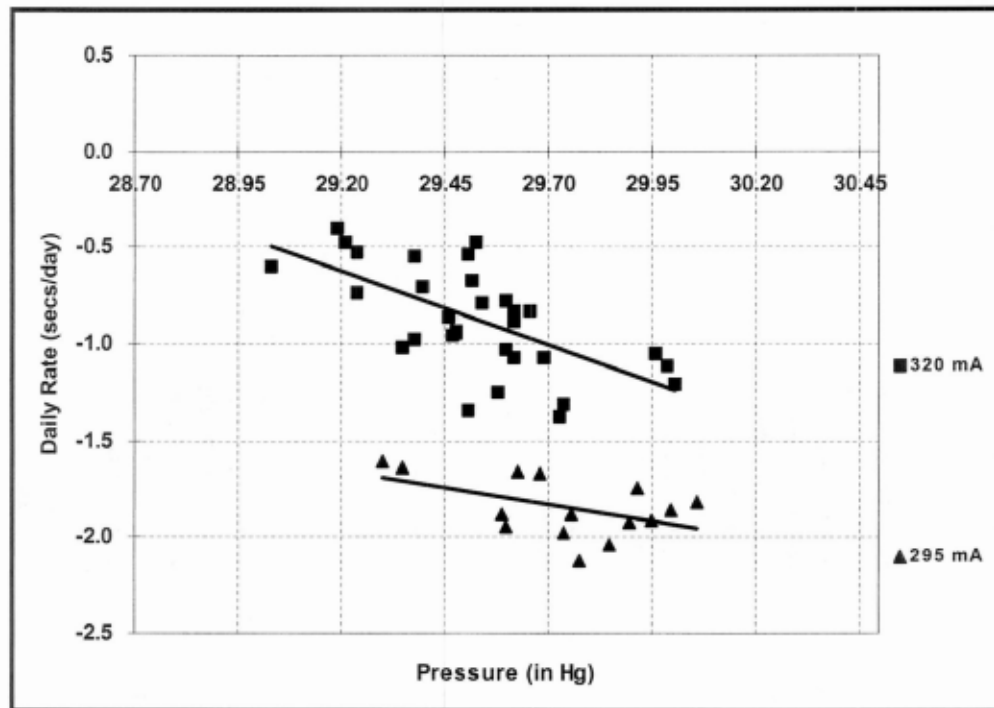

Fig. A2

Daily rate plotted against atmospheric pressure for two different currents. This shows that clock loses around 0.8 secs/day with lower current.

So, has this proved that the clock is current dependent? To be certain, further tests were carried out.

A constant current power supply was constructed that allowed the current to be varied, and this was used in place of the constant voltage supply and outboard resistance of the first test. With the constant current supply the clock showed no discernible difference in rate between 295 milliamps and 320 milliamps. However, when using the constant current supply the resetting action of the clock sounded different - sharper and snappier than when using the constant voltage supply. With constant voltage, the current builds up over the initial part of the resetting cycle due to the inductance of the coils, and it is this part of the cycle where the final part of impulse occurs. Using a constant current supply (with a high available voltage) the current is much higher in this initial phase compared with constant voltage; the resetting action is 40% quicker; and there is little effect on the

clock's performance with a current variation from 320 milliamps to 295 milliamps. This did not help prove my theory, but did show that a constant current supply should make a clock such as this more stable.

A test was then carried out comparing the clock running at the same nominal current using a constant voltage supply and a constant current supply. The test was carried out over two days in September 2000 when the weather forecast predicted stable atmospheric pressure and temperature. The pressure range was 0.27 inches of mercury, and the temperature range was 1.1 degree Celsius over the test period. Pendulum period was timed as before and samples were taken every few hours over the two-day period. The test was started by using the constant current supply. This was changed to the constant voltage supply at the same nominal current, without disturbing the pendulum, and then changed back to the constant current supply. The resulting changes in pendulum period are recorded in Fig.A3.

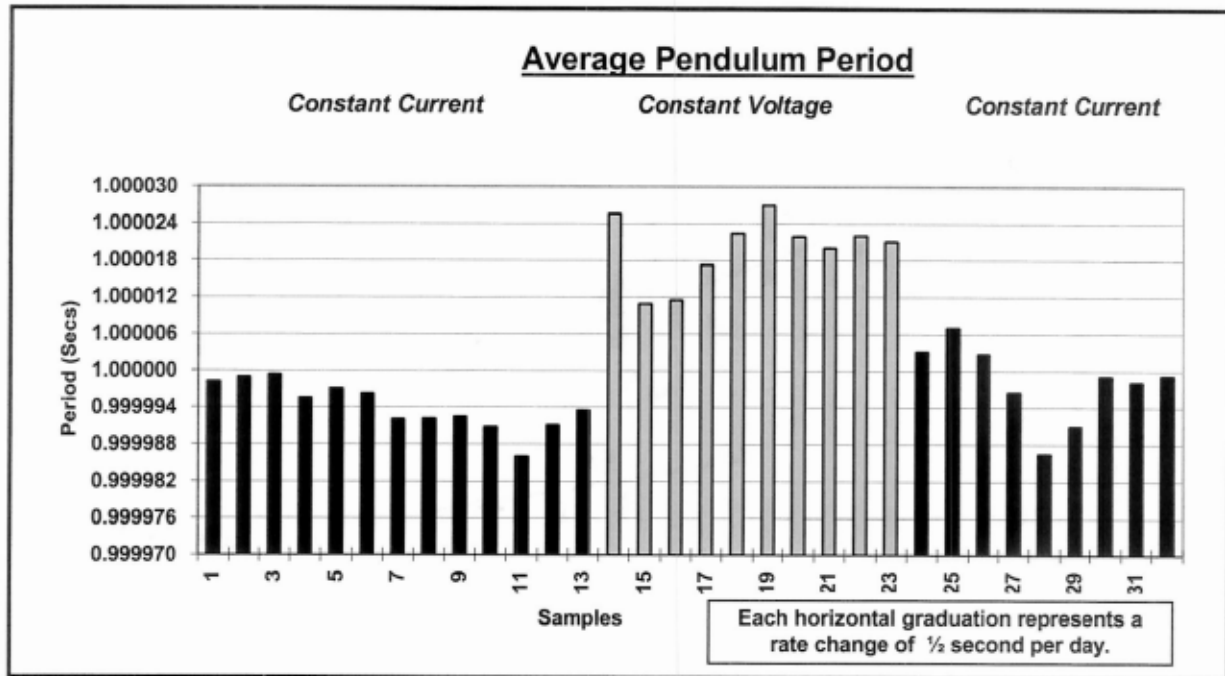

Fig. A3

Comparison of pendulum periods using constant current and constant voltage power supplies at the same nominal current of 320 mA.

The results of this test also show that the clock is current dependent. The constant voltage supply gives a lower current at the start of the resetting action and allows gravity arm impulse to carry on for longer than with constant current. With constant voltage, the pendulum arc increases and the period increases.

CONCLUSIONS

The rate of the ECS master clock is dependent on the supply current.

The reason for conducting the tests was to ascertain to what degree the imprecise termination of the pendulum impulse affects the clock.

The effect is not great, and in a commercial environment, the variation in rate is probably not significant.

However, as a late entry to the master clock market, it might be expected that the clock's design and performance would be at least as good as the competition, if not better.

APPENDIX 2**SERIES ½ MINUTE SLAVE MOVEMENT SPECIFICATIONS****Light duty movement EW/205/12 - 12-inch dial maximum (from an ECS document)**

Coil resistance	Shunt resistance	Combined resistance	Operating current	Coil part No.
3.5 to 3.8 ohms	33 ohms	3.1 to 3.5 ohms	0.3 to 0.32 amp	EW SEC 220

Coil - 730 turns 26 SWG enamelled copper wire.

G.P.O. Light duty movement EW/205/12/1 - 12-inch dial maximum (from an ECS document)

Coil resistance	Shunt resistance	Combined resistance	Operating current	Coil part No.
8.8 to 9.7 ohms	90 to 110 ohms	7.9 to 9.0 ohms	0.3 to 0.32 amp	P.71691

Coil - 1100 turns 29 SWG enamelled copper wire.

Light duty movement 205/19 - (from survey returns - data from labels on coils, and/or owners measurements) This movement has the following specification which is identical to 205/12:

Coil resistance	Shunt resistance	Combined resistance	Operating current	Coil part No.
3.5 to 3.8 ohms	33 ohms	3.1 to 3.5 ohms	0.3 to 0.32 amp	EW SEC 220

Medium duty movement EW/205/28 - 12-inch to 18-inch dial (from an ECS document)

Coil resistance	Shunt resistance	Combined resistance	Operating current	Coil part No.
6.8 to 7.5 ohms	68 ohms	6.1 to 6.8 ohms	0.3 to 0.32 amp	EW SEC 202

Coil - 1000 turns 28 SWG enamelled copper wire.

Heavy duty movement EW/245 - 18-inch to 36-inch dial (from an ECS document)

Referred to as a No. 3 movement

Coil resistance	Shunt resistance	Combined resistance	Operating current	Coil part No.
2 coils in series, each 7.0 to 8.5 ohms	150 ohms	12.6 to 15.4 ohms	0.3 to 0.32 amp	EW SEC 233

Coil - 1300 to 1395 turns 26 SWG enamelled copper wire.

ECS states that the working and failing currents of the above ECS dials are the same as similar Synchronome dials, and that they are interchangeable.

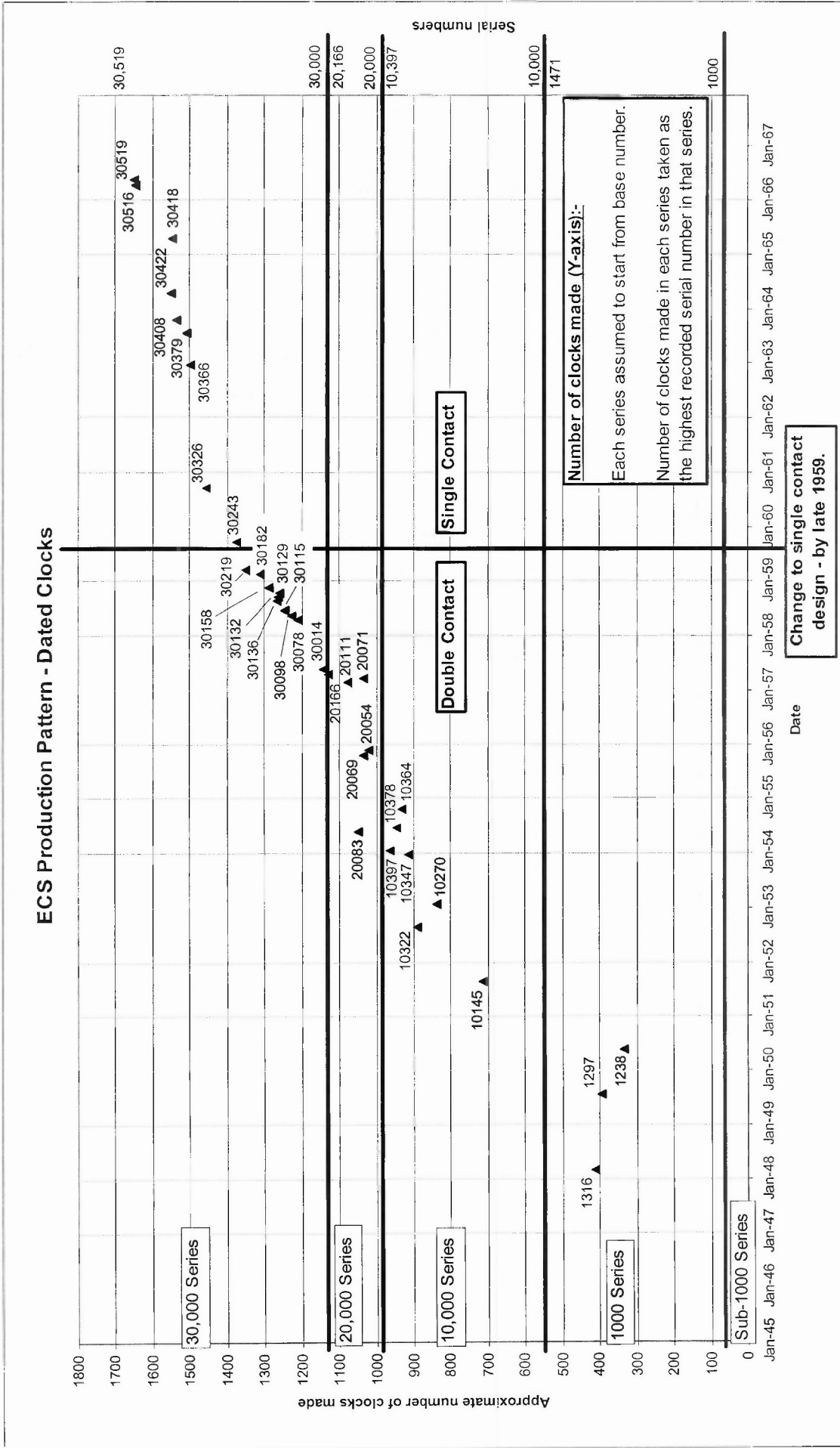

Chart 1

Dating information is predominantly derived from a date code on the pilot dial.

Design Changes

Serial Number	1000	10000	20000	30000	1945	1946	1947	1948	1949	1950	1951	1952	1953	1954	1955	1956	1957	1958	1959	1960	1961	1962	1963	1964	1965	1966
MASTER																										
Square Top																										
Round Top																										
Double Contact																										
Single Contact																										
Brass Link																										
Wire Link																										
2 piece Susp																										
1 piece Susp																										
Rounded Pallet																										
Angular Pallet																										
SLAVE																										
Roman																										
Arabic																										
Silvered																										
Painted																										
Old Hands																										
Intermediate																										
New Hands																										
Composition																										
Brass Wheel																										
Movt. 205/19																										
Movt. 205/12																										
Date																										

Chart 2

References:

- ¹ STS Company document - 'Particulars of Directors & Managers' 25 August 1936.
- ² Obituary, Horological Journal, March 1949, p160.
- ³ The British Clock Manufacturer (Special Supplement to the Goldsmiths Journal and the Watch and Clockmaker), February 1939
- ⁴ Interview with Mr. Ron Maurice, retired ECS employee.
Mr Maurice joined Synchro Time Systems around 1939 to be trained as a field service engineer. He worked all through the war and was field service engineer from 1940 to 1948/9. He became service manager in London when Mr Bailey died in 1949. Mr. Maurice retired from ECS in 1980 shortly before the take-over by Blick.
- ⁵ STS Company document - 'Special Resolution' 5 November 1937.
- ⁶ Horological Journal, August 1938.
- ⁷ The British Clock Manufacturer (Special Supplement to the Goldsmiths Journal and the Watch and Clockmaker), February 1939.
- ⁸ The British Clock Manufacturer (Special Supplement to the Goldsmiths Journal and the Watch and Clockmaker), February 1939.
- ⁹ STS Company document - 'Special Resolution' 28 March 1939, and Board of Trade document - approving name change, 15 April 1939.
- ¹⁰ ECS Annual Return, 25 December 1944.
- ¹¹ ECS Annual Return, 18 December 1947.
- ¹² ECS Annual Return, 29 December 1950.
- ¹³ ECS Annual Return, 18 November 1955.
- ¹⁴ D.W. Barrett joined Smiths at 16, became manager of SEC Ltd when it was formed, and remained there for over 50 years. He retired in 1967 as Managing Director of the Clock and Watch Division, and Chairman of several subsidiaries.
- ¹⁵ ECS Annual Return, 24 November 1943.
- ¹⁶ ECS Annual Return, 18 December 1947.
- ¹⁷ Interview with Mr. Rob Maurice, retired ECS employee.
- ¹⁸ Horological Journal, August 1990, p48.
- ¹⁹ Interview with Mr. Ron Maurice, retired ECS employee.
- ²⁰ Reports from a service practitioner with experience maintaining ECS systems.
- ²¹ Clock 1021/S carries a pencilled service date of August 1950, so must pre-date this.
- ²² Interview with Mr. Ron Maurice, retired ECS employee.
- ²³ Correspondence with a retired employee of the S. African agent, who had been trained to make the modification.
- ²⁴ Data collated by Derek Bird and John Howell.
- ²⁵ Data from Arthur Mitchell and Paul Joyce.